

*Built-in part **0274015X** mandatory

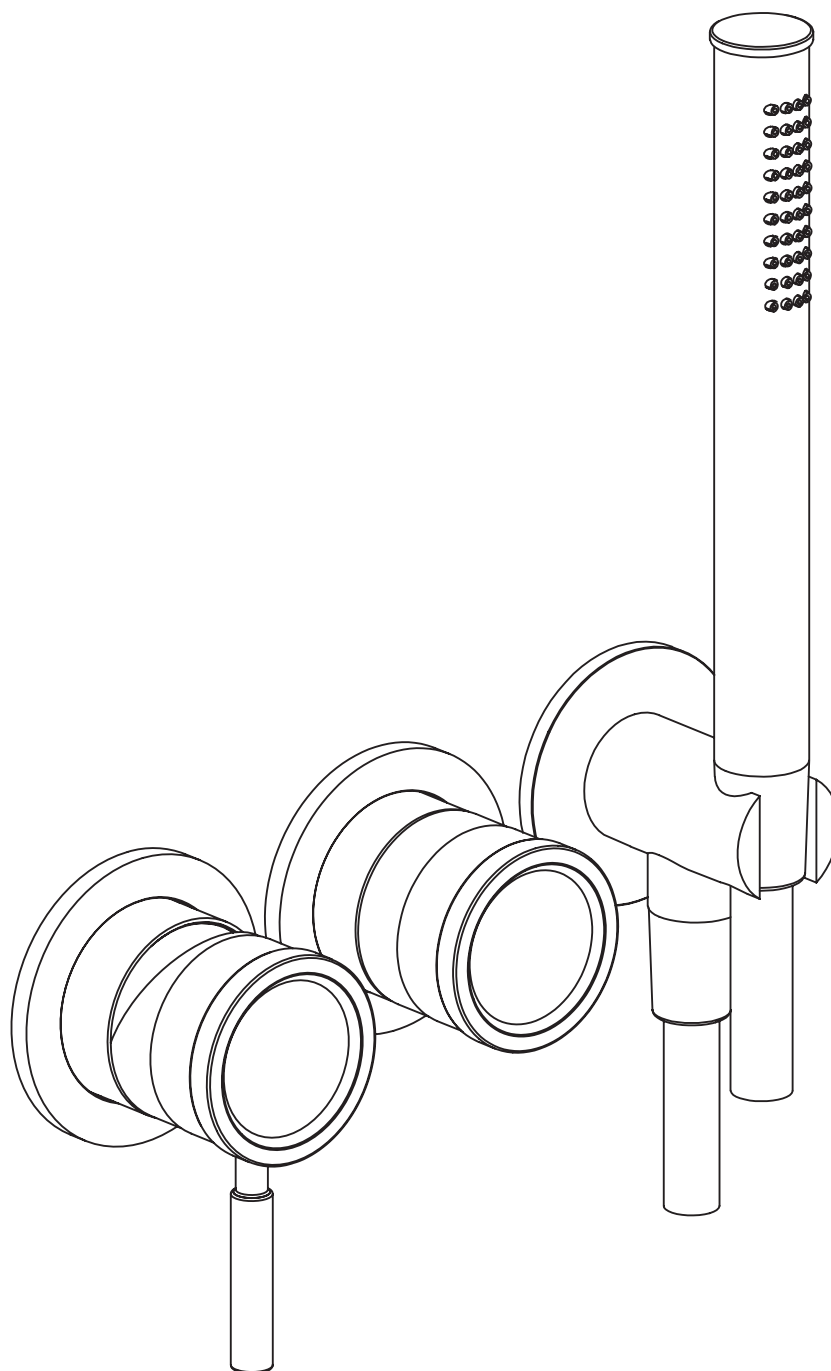

0285412X

EXTERNAL PART 2 - WAY BUILT - IN MIXER WITH ROTATING DIVERTER, SHOWER SET
WITH WATER CONNECTION

