

*Necessario incasso 0274015X

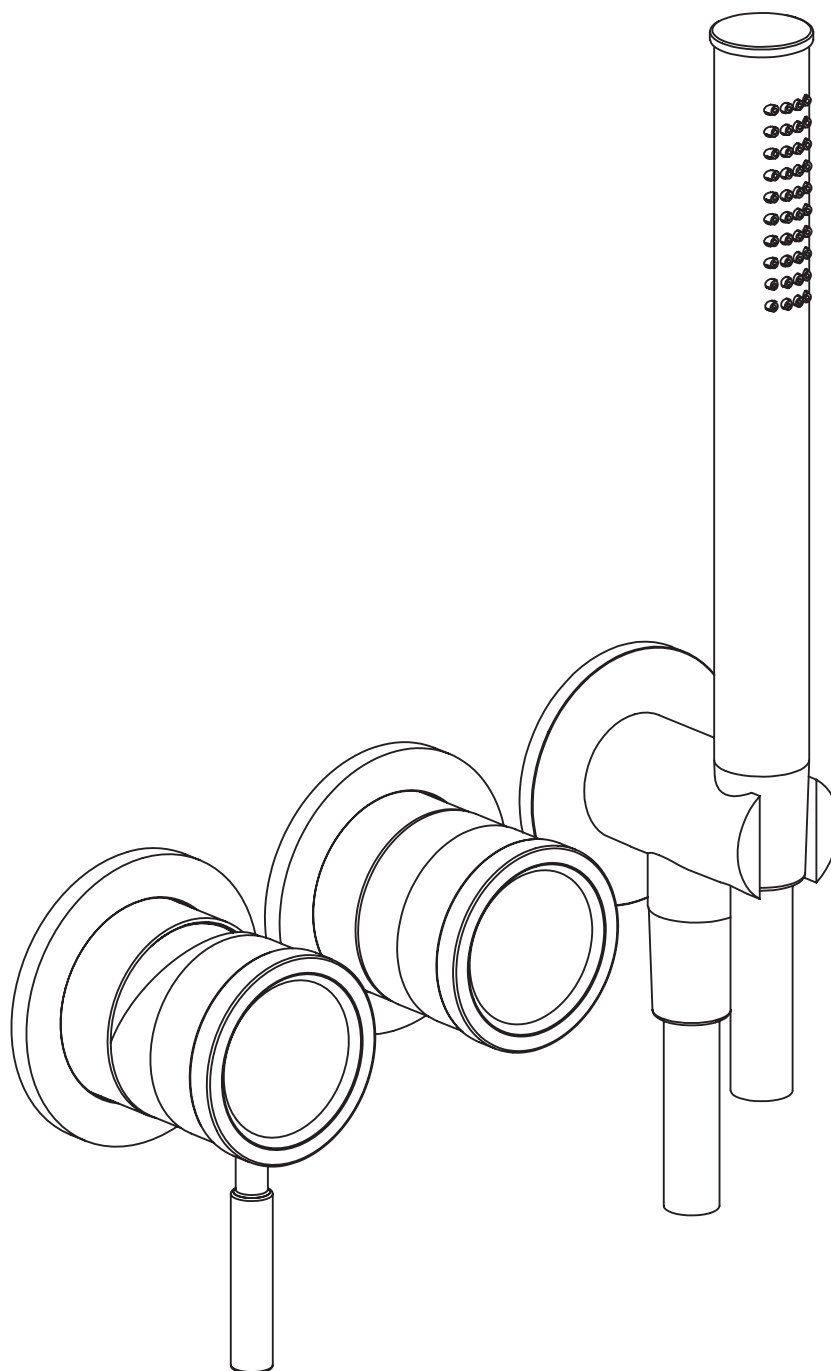

0285412X

PARTE ESTERNA MISCELATORE MONOCOMANDO INCASSO DUE VIE C / DEVIATORE
ROTATIVO, DOCCETTA, FLESSIBILE 160CM, P. ACQUA E SUPPORTO DOCCIA

